

Reling pozdĺžny

Reling podłużny
Keresztűrd

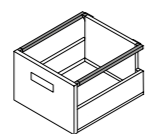

Dĺžka Długość / Hosszúság	Šedý Grafit / Szürke	Biely Biały / Fehér	Čierny Czarny / Fekete	Cena EUR bez DPH
L450 mm	05GL18SBREL450G	05GL18SBREL450W		
L500 mm	05GL18SBREL500G	05GL18SBREL500W		
L550 mm	05GL18SBREL550G	05GL18SBREL550W		

Reling priečny

Reling poprzeczny
Keresztűrd

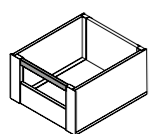

Dĺžka Długość / Hosszúság	Šedý Grafit / Szürke	Biely Biały / Fehér	Čierny Czarny / Fekete	Cena EUR bez DPH
L2000 mm	05GL18SBPRG	05GL18SBPRW		

Predný panel vnútornej zásuvky

Przedni panel do szuflady wewnętrznej
Belső fiók előlap

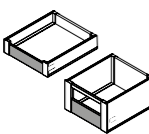

Dĺžka Długość / Hosszúság	Šedý Grafit / Szürke	Biely Biały / Fehér	Čierny Czarny / Fekete	Cena EUR bez DPH
L2000 mm	05GL18SBPANELG	05GL18SBPANELW		

Úchyt čela vnútornej zásuvky

Uchwyt frontu szuflady wewnętrznej
Magas belső fiók előlaprögzőtő

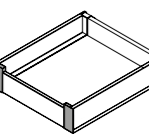

Výška PL / HU	Šedý Grafit / Szürke	Biely Biały / Fehér	Čierny Czarny / Fekete	Cena EUR bez DPH
"A"	05GL18SBUCHYTAG	05GL18SBUCHYTAW		
"C"	05GL18SBUCHYTCG	05GL18SBUCHYTCW		

Zadná regulácia sklonu čela

Tylna regulacja pochylenia frontu
hátsó szabályozás az oldalfal dőléshez



Pre hrúbku dna a chrbta 18 mm

Dno i ścianka tylna 18 mm
18 mm vastag fenékhez és háttalhoz

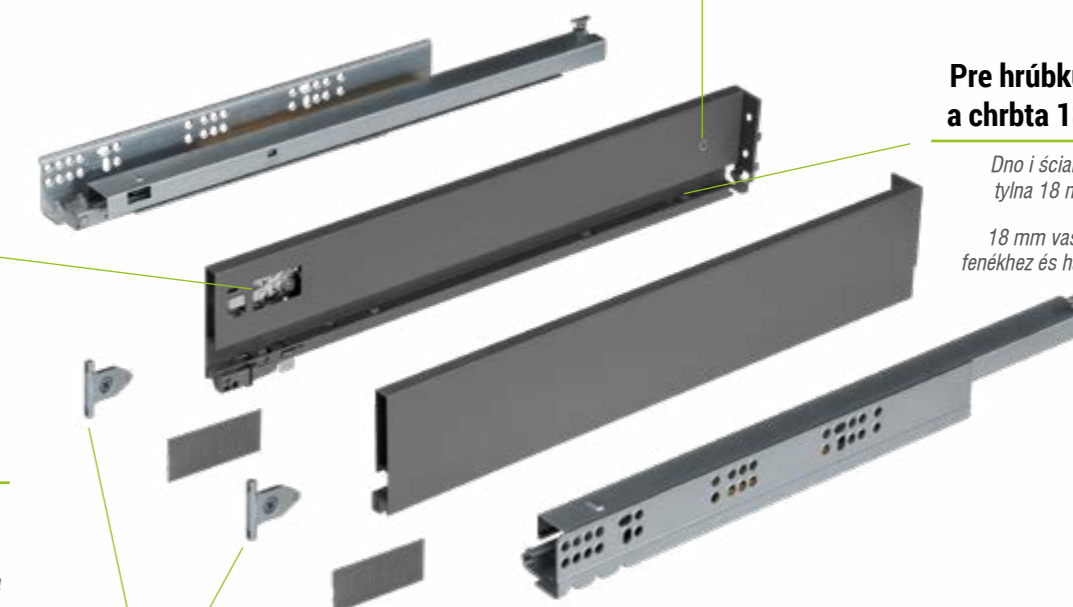

3D nastavenie čela zásuvky

Regulacja 3D frontu szuflady
a fiókdal 3D-s beállítása

Kovové úchyty čela zásuvky

Metalowe mocowania frontu szuflady
fém előlaprögzőtő

Obchodní zástupcovia:

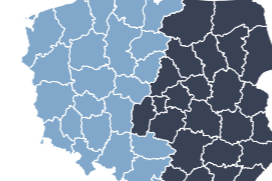
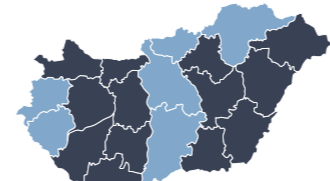
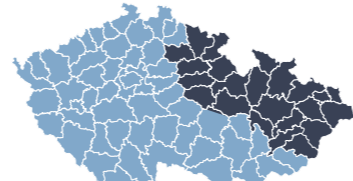
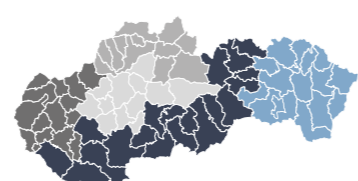

Slovenská republika

tel.: +421 911 500 638
e-mail: timko@lunit.sk
tel.: +421 905 644 228
e-mail: kvasna@lunit.sk
tel.: +421 903 105 412
e-mail: benko@lunit.sk
tel.: +421 911 328 761
e-mail: dorcak@lunit.sk
tel.: +421 903 935 426
e-mail: brazdil@lunit.sk

Česká republika

tel.: +420 725 912 091
e-mail: halagacka@lunit.sk
tel.: +420 722 926 695
e-mail: hanzlova@lunit.sk

Magyarország

tel.: +36 308 598 016
e-mail: becse@lunit.sk
tel.: +36 305 330 712
e-mail: lunit.hu@gmail.com

LUNIT Polska

ul. Strzelców Bytomskich 98
41-906 Bytom
Akcesoria
tel.: +48 518 635 638
e-mail: akcesoria@lunitpolska.eu
Fronty
tel.: +48 509 949 184
email: fronty@lunitpolska.eu
Dyrektor handlowy
tel.: +48 515 668 521
email: p.niedbala@lunitpolska.eu
Przedstawiciele handlowi
tel.: +48 517 412 777
email: s.niedbala@lunitpolska.eu
tel.: +48 518 171 002
email: j.krupa@lunitpolska.eu

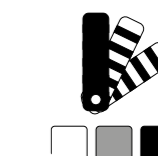
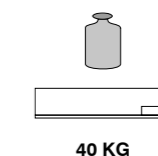
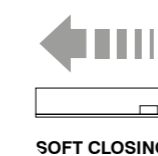

SMARTBOX Line 18 - A / Nízky
 SMARTBOX Line 18 - A / Niski
 SMARTBOX Line 18 - A / alacsony

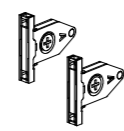
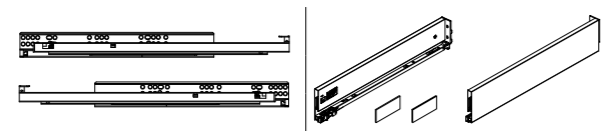

H90 Nízky	Šedý	Biely	Čierny
<i>Niski / alacsony</i>	<i>Grafit / Szürke</i>	<i>Biały / Fehér</i>	<i>Czarny / Fekete</i>
L300 mm	05GL18SB300GA	05GL18SB300WA	
L350 mm	05GL18SB350GA	05GL18SB350WA	
L400 mm	05GL18SB400GA	05GL18SB400WA	
L450 mm	05GL18SB450GA	05GL18SB450WA	05GL18SB450BA
L500 mm	05GL18SB500GA	05GL18SB500WA	05GL18SB500BA
L550 mm	05GL18SB550GA	05GL18SB550WA	

SMARTBOX Line 18 - B / Stredný
 SMARTBOX Line 18 - B / Sredni
 SMARTBOX Line 18 - B / közepes

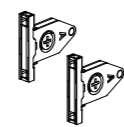
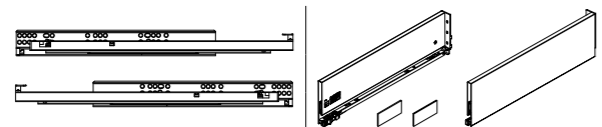

H128 Stredný	Šedý	Biely	Čierny
<i>Sredni / közepes</i>	<i>Grafit / Szürke</i>	<i>Biały / Fehér</i>	<i>Czarny / Fekete</i>
L300 mm	05GL18SB300GB	05GL18SB300WB	
L350 mm	05GL18SB350GB	05GL18SB350WB	
L400 mm	05GL18SB400GB	05GL18SB400WB	
L450 mm	05GL18SB450GB	05GL18SB450WB	05GL18SB450BB
L500 mm	05GL18SB500GB	05GL18SB500WB	05GL18SB500BB
L550 mm	05GL18SB550GB	05GL18SB550WB	

SMARTBOX Line 18 - C / Vysoký
 SMARTBOX Line 18 - C / Wysoki
 SMARTBOX Line 18 - C / magas

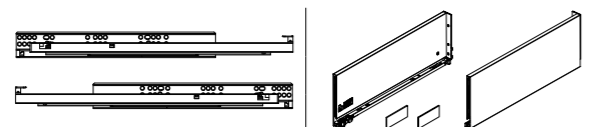

H175 Vysoký	Šedý	Biely	Čierny
<i>Wysoki / magas</i>	<i>Grafit / Szürke</i>	<i>Biały / Fehér</i>	<i>Czarny / Fekete</i>
L300 mm	05GL18SB300GC	05GL18SB300WC	
L350 mm	05GL18SB350GC	05GL18SB350WC	
L400 mm	05GL18SB400GC	05GL18SB400WC	
L450 mm	05GL18SB450GC	05GL18SB450WC	05GL18SB450BC
L500 mm	05GL18SB500GC	05GL18SB500WC	05GL18SB500BC
L550 mm	05GL18SB550GC	05GL18SB550WC	

SMARTBOX Line 18 - D / Extra Vysoký
 SMARTBOX Line 18 - D / Extra Wysoki
 SMARTBOX Line 18 - D / extra magas

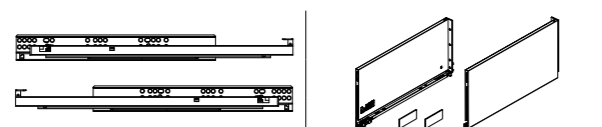

H239 Extra Vysoký	Šedý	Biely	Čierny
<i>Extra Wysoki / extra magas</i>	<i>Grafit / Szürke</i>	<i>Biały / Fehér</i>	<i>Czarny / Fekete</i>
L300 mm	05GL18SB300GD	05GL18SB300WD	
L350 mm	05GL18SB350GD	05GL18SB350WD	
L400 mm	05GL18SB400GD	05GL18SB400WD	
L450 mm	05GL18SB450GD	05GL18SB450WD	05GL18SB450BD
L500 mm	05GL18SB500GD	05GL18SB500WD	05GL18SB500BD
L550 mm	05GL18SB550GD	05GL18SB550WD	

Vnútro skrinky - požiadavky

Wymagana przestrzeń wewnątrz korpusu

A szekrény belseje - követelmények

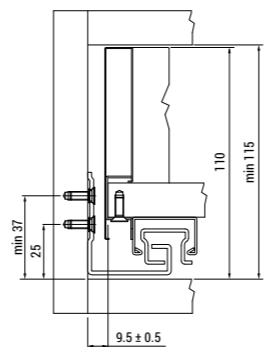

Pozície montáže predného panelu

Wymiary montażowe frontu szuflady

Az előlap rögzítési pozíciói

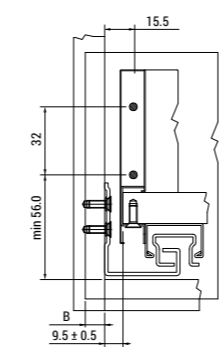

Pozície montáže predných úchyto

Polozenie wymiarów montażowych na froncie

Az előlaprögzítők rögzítési pozíciói

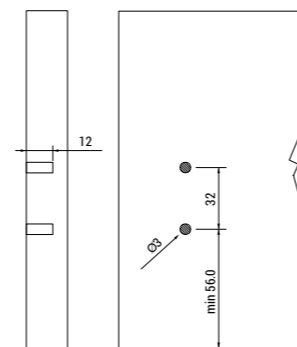

Pozície montáže chrbta

Wymiary montażowe ścianki tylnej

A hátlap rögzítési pozíciói

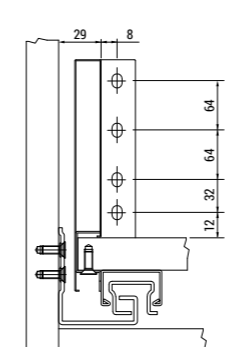
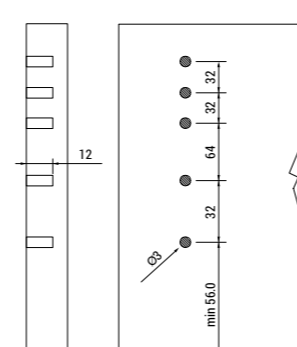
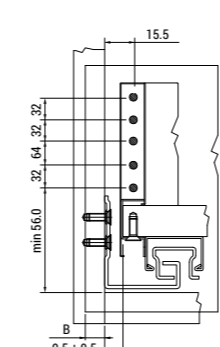
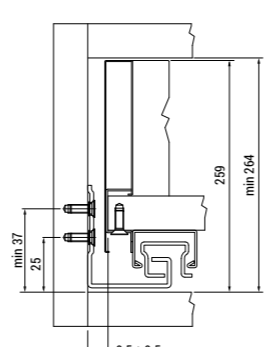
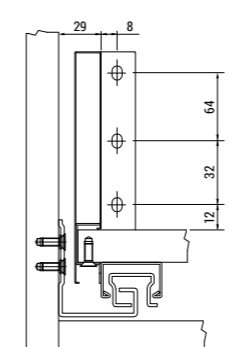
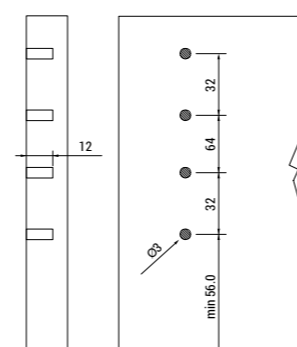
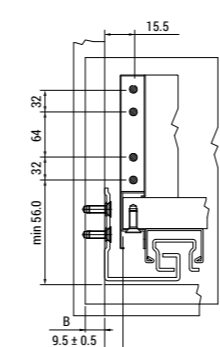
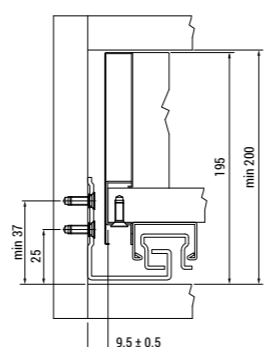
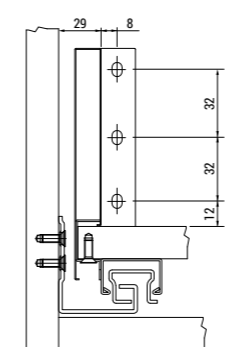
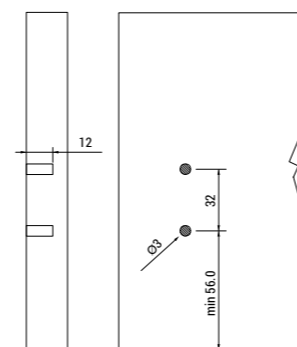
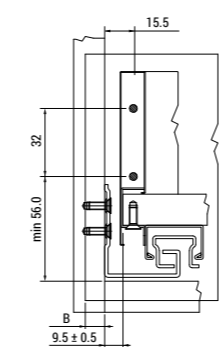
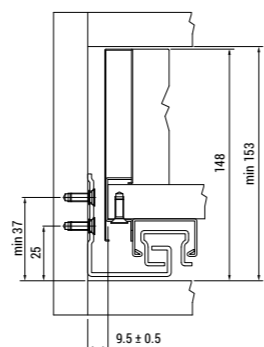
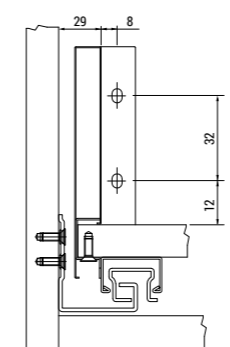

Dĺžka	Využitelná hĺbka	Min. hĺbka pre inštaláciu	Min. výška pre inštaláciu
<i>Długość Hosszúság</i>	<i>Głębokość użytkowa Használható mélység</i>	<i>Min. głębokość do montażu A beépítés min.mélysége</i>	<i>Min. wysokość do montażu A beépítés min.magassága</i>
300 mm	270 mm	305 mm	115 mm
350 mm	320 mm	355 mm	115 mm
400 mm	370 mm	405 mm	115 mm
450 mm	420 mm	455 mm	115 mm
500 mm	470 mm	505 mm	115 mm
550 mm	520 mm	555 mm	115 mm

Dĺžka	Využitelná hĺbka	Min. hĺbka pre inštaláciu	Min. výška pre inštaláciu
<i>Długość Hosszúság</i>	<i>Głębokość użytkowa Használható mélység</i>	<i>Min. głębokość do montażu A beépítés min.mélysége</i>	<i>Min. wysokość do montażu A beépítés min.magassága</i>
300 mm	270 mm	305 mm	153 mm
350 mm	320 mm	355 mm	153 mm
400 mm	370 mm	405 mm	153 mm
450 mm	420 mm	455 mm	153 mm
500 mm	470 mm	505 mm	153 mm
550 mm	520 mm	555 mm	153 mm

Dĺžka	Využitelná hĺbka	Min. hĺbka pre inštaláciu	Min. výška pre inštaláciu
<i>Długość Hosszúság</i>	<i>Głębokość użytkowa Használható mélység</i>	<i>Min. głębokość do montażu A beépítés min.mélysége</i>	<i>Min. wysokość do montażu A beépítés min.magassága</i>
300 mm	270 mm	305 mm	200 mm
350 mm	320 mm	355 mm	200 mm
400 mm	370 mm	405 mm	200 mm
450 mm	420 mm	455 mm	200 mm
500 mm	470 mm	505 mm	200 mm
550 mm	520 mm	555 mm	200 mm

Dĺžka	Využitelná hĺbka	Min. hĺbka pre inštaláciu	Min. výška pre inštaláciu
<i>Długość Hosszúság</i>	<i>Głębokość użytkowa Használható mélység</i>	<i>Min. głębokość do montażu A beépítés min.mélysége</i>	<i>Min. wysokość do montażu A beépítés min.magassága</i>
300 mm	270 mm	305 mm	264 mm
350 mm	320 mm	355 mm	264 mm
400 mm	370 mm	405 mm	264 mm
450 mm	420 mm	455 mm	264 mm
500 mm	470 mm	505 mm	264 mm
550 mm	520 mm	555 mm	264 mm

X	
Smartbox 18 A	63 mm
Smartbox 18 B	101 mm
Smartbox 18 C	148 mm
Smartbox 18 D	212 mm

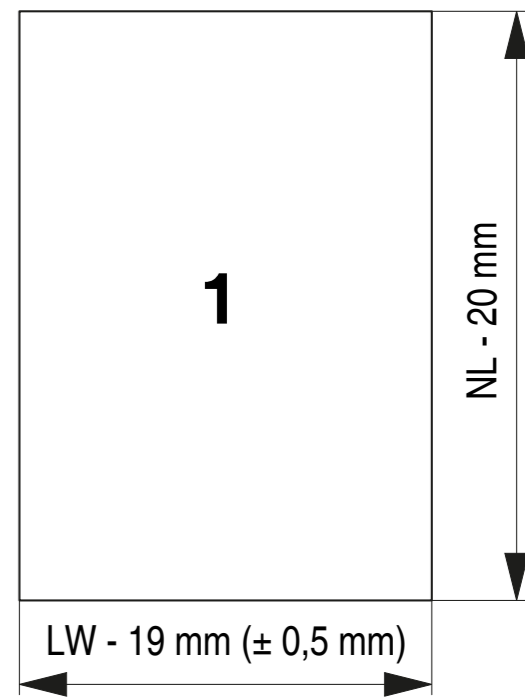
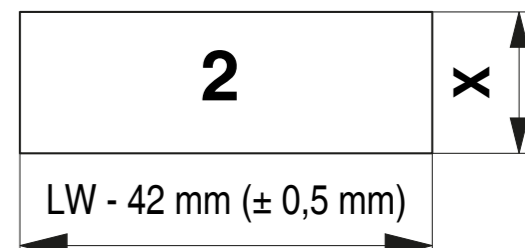

1= Dno zásuvky

Dno szuflady / A fiók fenéklapja

2= Chrbát zásuvky

Ścianka tylna szuflady / A fiók hátlapja

X= Výška chrbta zásuvky

Wysokość ścianki tylnej szuflady / A fiók hátlapjának a magassága

LW= Vnútrošná šírka skrinky

Wewnętrzna szerokość korpusu / A szekrény belső szélessége

NL= Dĺžka výsuvu

Długość prowadnicy / A fiókcúszó hossza